

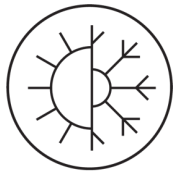

**White Tunable Compact Driver**

The DMR-AOD series of white tunable compact drivers offers universal input voltage, CCT tunable with dual 0-1-10V dimming control. It has superior performance for small to medium size light fixtures, such as downlights, tracklights/spotlights and wall sconces where small form factor, precise CCT tunable control, flicker free, and high reliability are critical factors.



**CCT TUNABLE**



**UNIVERSAL INPUT VOLTAGE**

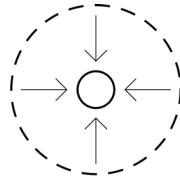

**COMPACT SIZE**



**DEEP DIMMING**

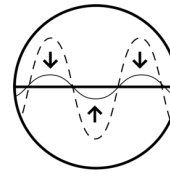

**FLICKER FREE**



**5 YEAR WARRANTY**

**Product Offering**

Part number: **DMR-AOD042/2-PC1K1-40**

**Features**

- Compact size, small form factor
- Universal input (100-277 VAC)
- Excellent percent flicker <5%
- Programmable : 150mA to 1050mA
- Deep dimming, down to 0.1%
- Flicker free
- UL Class P certified
- Removable strain relief
- Works with Luminus' CTM COBs



116.9 x 62.5x 27mm

**1 – Input Characteristics**

Parameter	Specification	Condition
Nominal Input Voltage Range	100 – 277 VAC	
Maximum Input Voltage	90 – 305 VAC	
Maximum Input Current	0.4A @120V 0.18A @277V	Full output power
Input Frequency	50/60Hz	Performance range
Power Factor @ Full Load	>0.9	Full output power @120 / 277VAC input
Efficiency	>87% @120V >85% @277V	Full output power
THD @ Full Load	<20%	At nominal input voltage and LED voltage
Maximum Inrush Current	<10 A	At 120V and 277V input 25C cold start
No load power consumption	<0.5 W	
Start-up Time	< 0.5 s	





## 2 – Output Characteristics/Channel

Parameter	Specification	Condition
Rated LED Output Power	6 - 42W	
Nominal Output Current	150 – 1050mA	
Output Current Tolerance	±3%	
Output Current Frequency over dimming	420Hz	
Output Voltage Range	12 – 40VDC	
Open Loop Voltage	<47 V	
Percent Flicker	5%	For frequencies of 200Hz or below at 100% and 20% light output

## 3 – Dimming Characteristics

Parameter	Specification	Condition
Control Channels	2	
Dimming Protocol	0/1 – 10V	
Dimming Range	0.1% - 100%	
Dim+/Dim-	0/1 - 10V	The Dim+/Dim- inputs can be used used to adjust the output via a standard commercial wall dimmer, an external control voltage source (0 to 10 Vdc), or a variable resistor
Current supplied by Dim+/Dim-	< 1mA	





#### 4 – Environmental Conditions

Parameter	Specification	Condition
Ambient Temperature Range (Ta)	-10 to 40 °C	Higher ambient temperatures are possible so long as Tc max is not exceeded
Max. Ambient Temperature	40 °C	Ta max
Max. Case Temperature (Tc)	85 °C	Tc max, case temperature measured at the Tc mark on driver housing
Storage Temperature	-20 to 90°C	
Relative Humidity	80%	Non-condensing
Lifetime @ Tc max	50,000 hours	
Driver Warranty	5 years	
Combines Warranty (When combined with compatible Luminus COB + Cuvee Driver, contact Luminus for more info)	5 years	

#### 5 – Protection Features

Parameter	Specification	Condition
Overload	yes	Automatic recovery
Over Current Protection (OCP)	yes	Automatic recovery
Output Short Circuit Protection (SCP)	yes	Automatic recovery
Over Temperature Protection (OTP)	yes	Gradually reduce output power when max Tc is exceeded. Automatic recovery
Surge Protection	1kV	





6 – Outline Drawing

6.1a – Outline Drawing

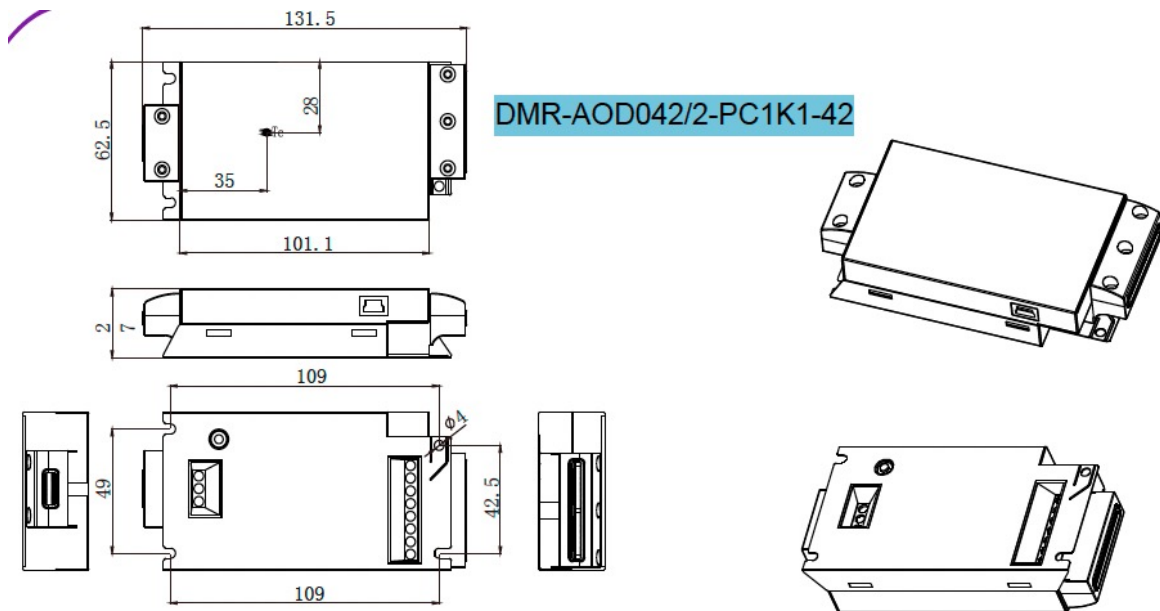

6.1a – Mechanical Details

Parameter	Specification	Condition
Housing Design	Rectangular Metal Case	
Housing Size	131.5 x 62.5x 27mm (w/strain relief)	
Wire Terminal Connections	Side Feed	
Connector Type	Poke-in	
Wire Size	0.5 – 1.0 (24 – 18 gauge)	Solid or tinned stranded





6 – Outline Drawing

6.1b – Outline Drawing with strain relief removed

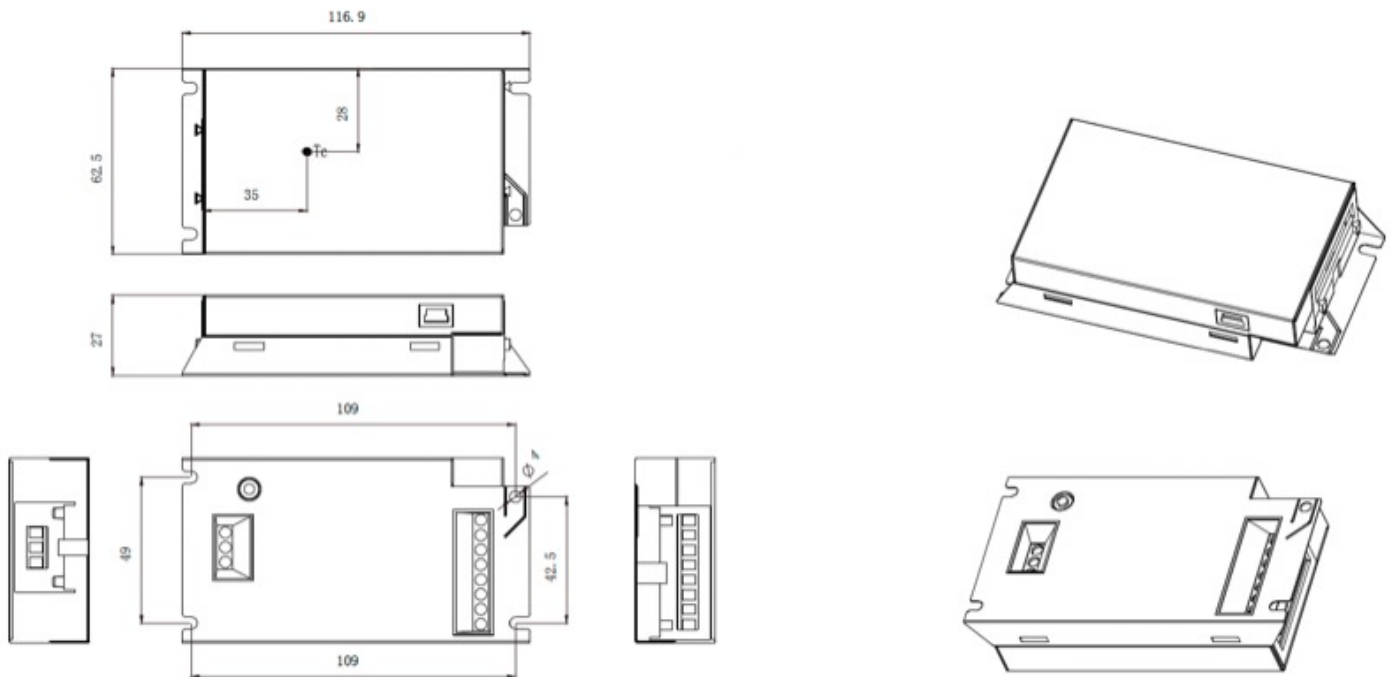

6.1a – Mechanical Details

Parameter	Specification	Condition
Housing Design	Rectangular Metal Case	
Housing Size	116.9 x 62.5x 27mm (with strain relief removed)	
Wire Terminal Connections	Side Feed	
Connector Type	Poke-in	
Wire Size	0.5 – 1.0 (24 – 18 gauge)	Solid or tinned stranded





## 7 – EMC Compliance Approvals

Parameter	Specification	Condition
EMI Conducted and Radiated	FCC CFR Title 47 Part 15 Class B	At 120 and 277VAC
Harmonic Current Emissions	IEC 61000-3-2014	For Class C equipment
Voltage Fluctuations & Flicker	IEC 6000-3-3-2013	
ESD (Electrostatic Discharge)	IEC 61547 Section 5.3	4kV contact discharge
	Test des.: IEC 61000-4-4	8kV air discharge, level 3
Continuous Radiated Disturbance	IEC 61547 Section 5.3	
	Test des.: IEC 60001-4-3	3V/m, 80-1000MHz, 80% modulated at 3m
Electrical Fast Transient	IEC 61547 Section 5.5	+/-1kV on AC power port for 1 minute
	Test des.: IEC 60001-4-4	+/-1kV on sign/control lines
Surge	IEC 61547 Section 5.6	
	Test des.: IEC 60001-4-5	+/-1kV line to line (differential mode)
Continuous Conducted Disturbance	IEC 61547 Section 5.4	
	Test des.: IEC60001-4-6	3V, 0.15 – 80MHz, 80% modulated, level 2
Power Frequency Magnetic Field	IEC 31547 Section 5.4	
	Test des.: IEC 60001-4-8	3A, 50/60Hz, level 2
Voltage Dips	IEC 61547 Section 5.8, 5.9	70% dip during 25 cycles @50Hz, 30
	Test des.: IEC 60001-4-11	cycles@60Hz 0% dip during ½ cycles

## 8 – Safety Agency Approvals

Parameter	Specification	Condition
UL / cUL	UL 8750	UL Listed, Class P (Class 2 Output) (ES14800)
CE	EN61347-1:2015	
	EN61347-2-13:2014/A1:22017	





### Kaoyi to generate graphs (120V)

#### 9 – Graphs (120V)

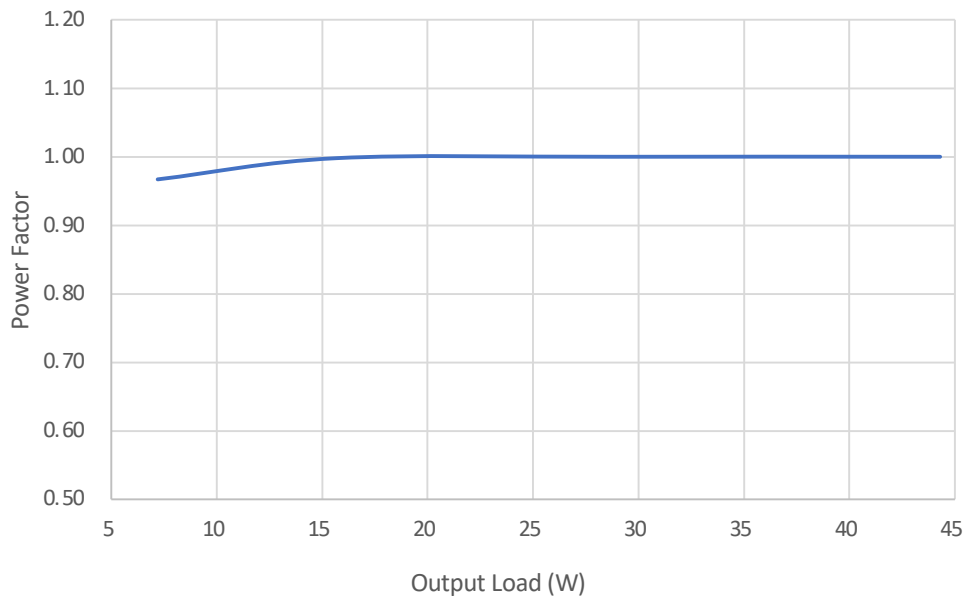
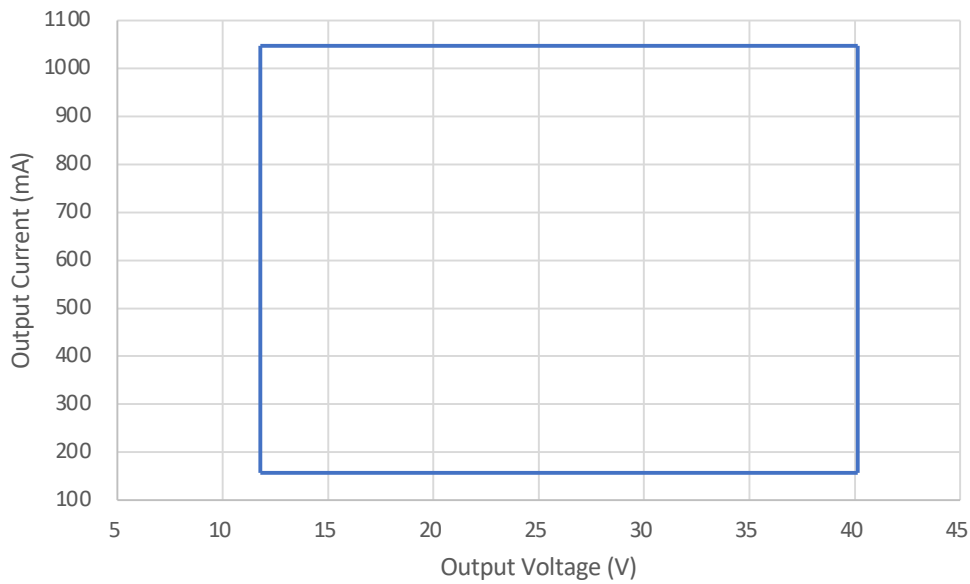



### Kaoyi to generate graphs (120V)

#### 9 – Graphs (120V)

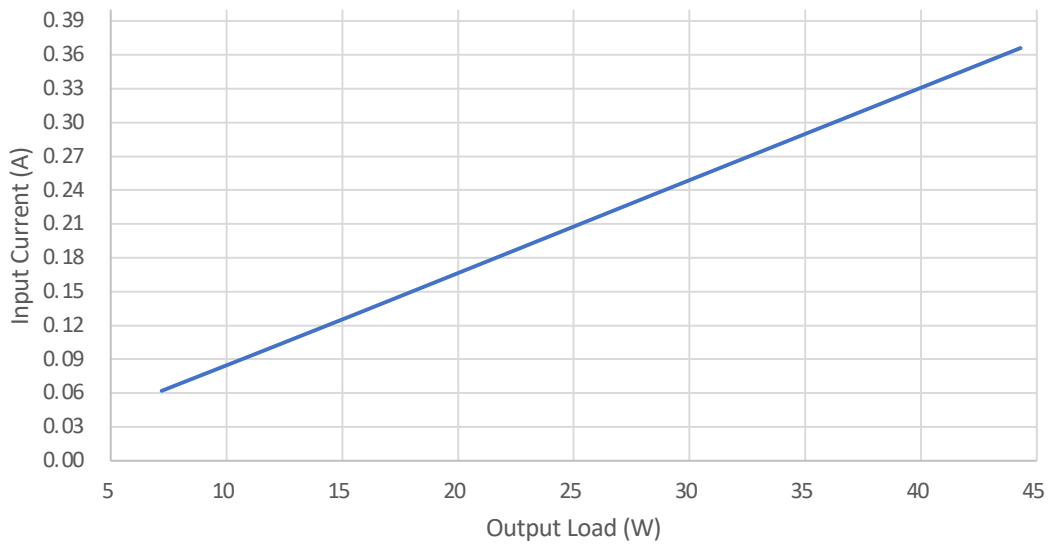
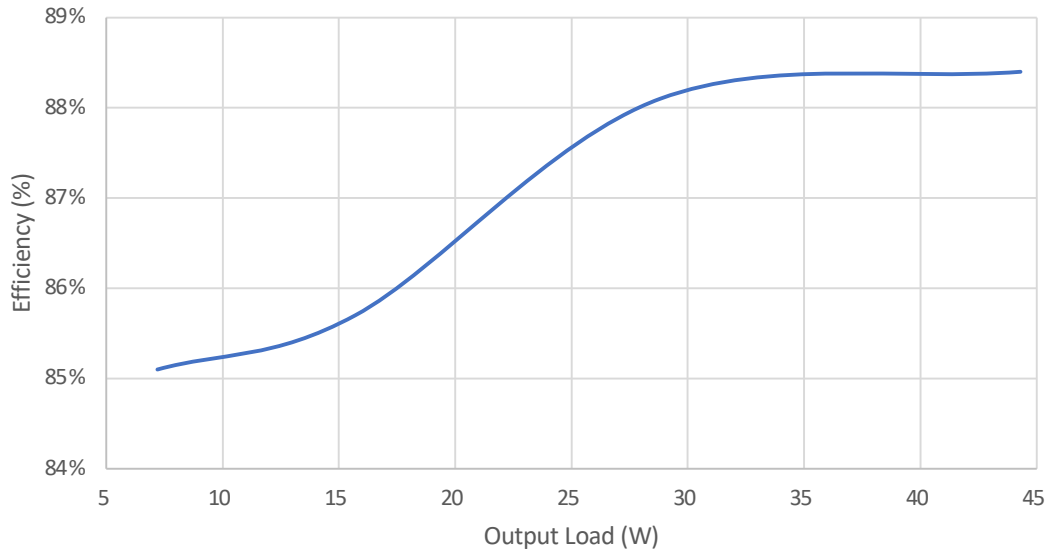





Kaoyi to generate graphs (120V)

9 – Graphs (277V)

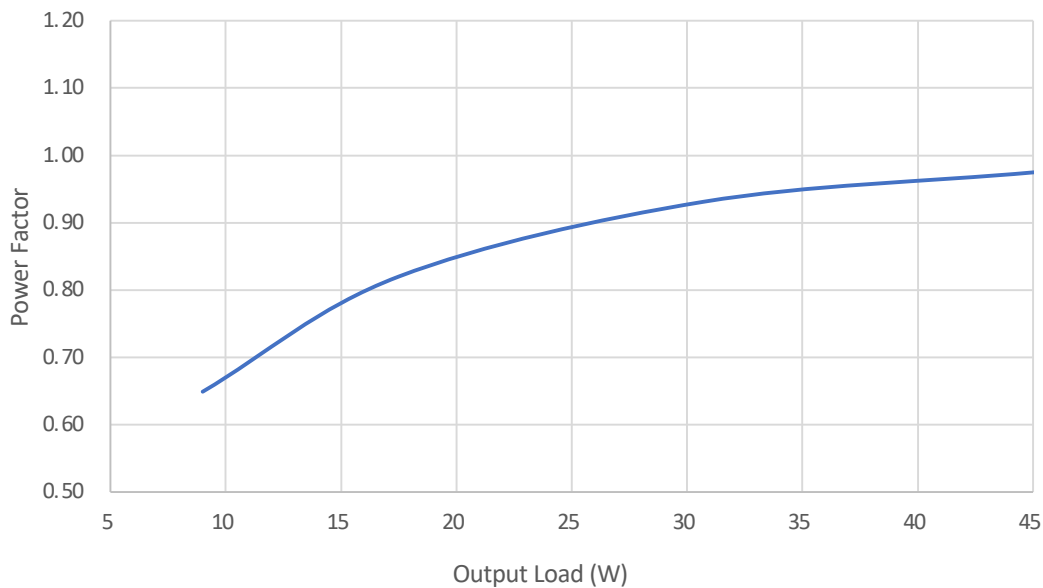
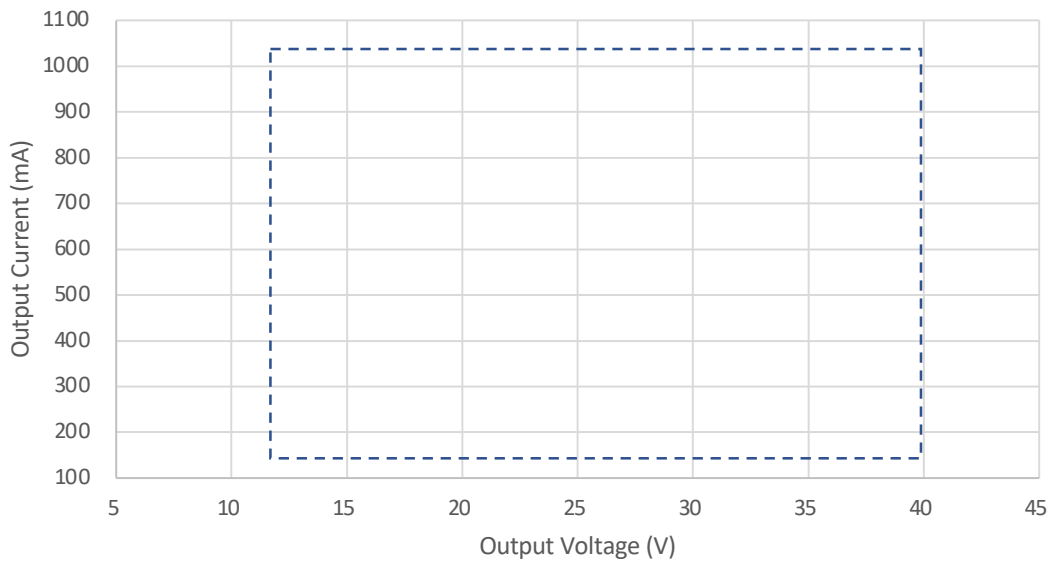



### Kaoyi to generate graphs (120V)

#### 9 – Graphs (277V)

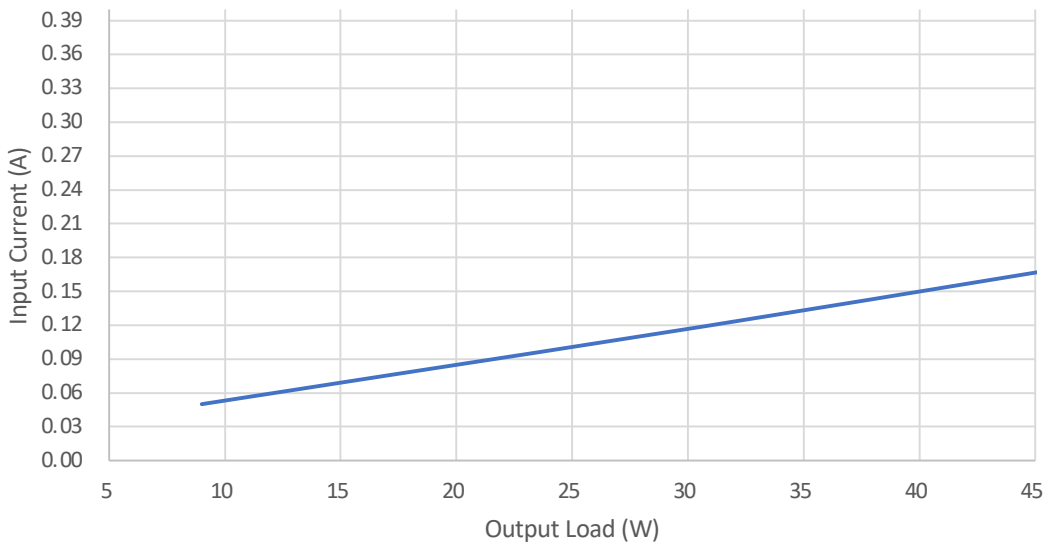
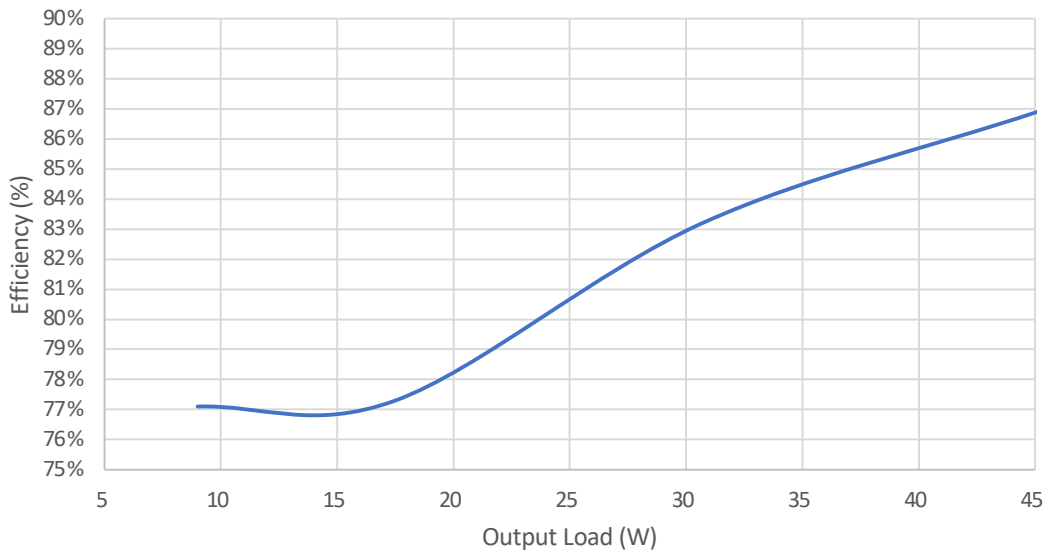



12 – Wiring Diagram

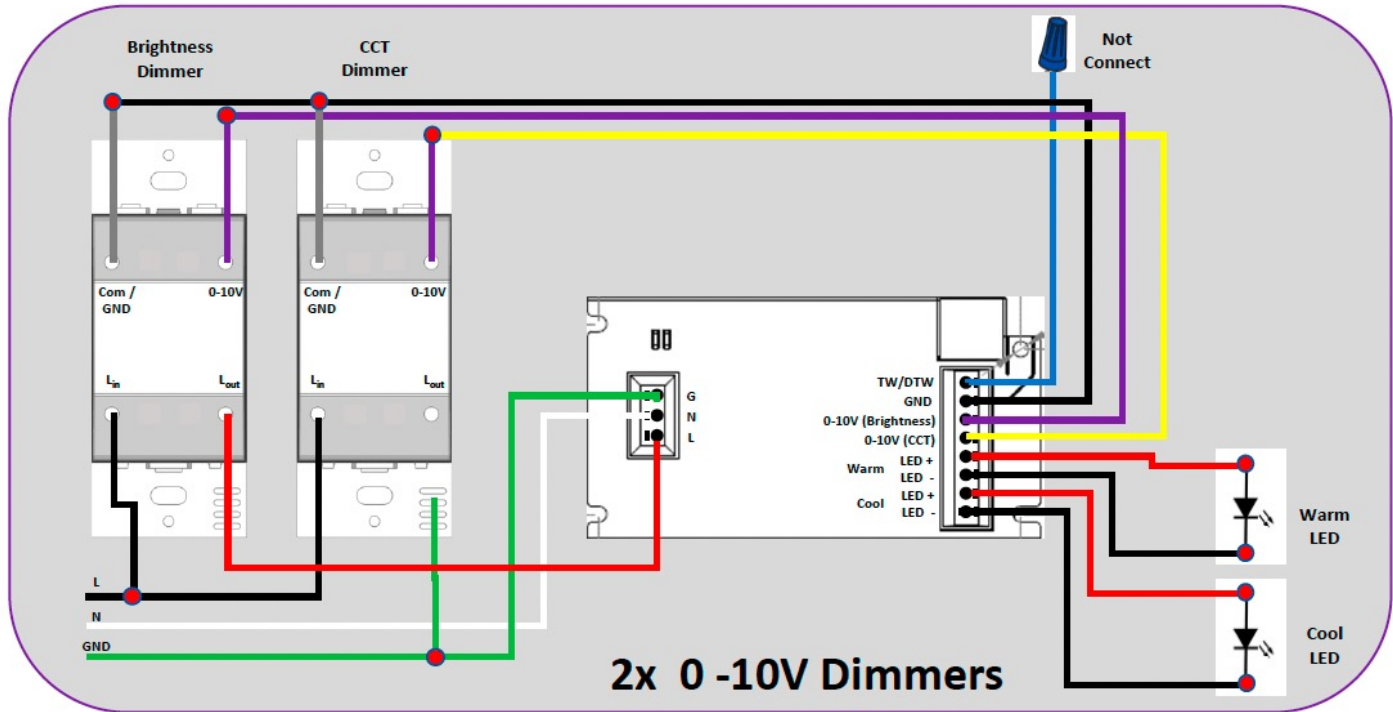

13 – Programming Cable & Software

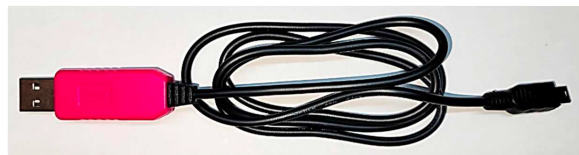

**Programming Cable**

The programming cable, DMR-PROG-USB consists of a cable with a USB A at one end and a mini-USB at the other. The mini-USB connector plugs into the side of the CCT Tunable Driver.

**Programming Software**

The programming software runs a Microsoft PC with Windows 10 or greater OS. It is available on the Cuvee Systems website, <http://cuveesystems.com/solution-portfolio/cct-tunable-driver/>. Fill out the request form and the software will be emailed to you.

13 – Ordering Info

Product	Part Number
42W CCT Tunable Driver	DMR-AOD042/2-PC1K1-40
USB Programming Cable	DMR-PROG-USB