



15W Compact Waterproof LED Driver

The DR8 series of compact waterproof LED drivers offers superior performance for small to medium size lighting fixtures, such as pool, spa, landscape and in-ground lighting where form factor, precise light control, quality of light and high reliability are critical factors.

Product Offering

Power: 15 W
 Input: 220-240 V (50/60 Hz)
 Output: 350 mA (30-42 V)
 Dimming: Leading and Trailing edge
 IP rating: IP68



Features and Benefits

Waterproof	IP68 permanent submersion in water (4 meters).
Compact Size	Specifically designed to fit in small lighting fixtures with integrated waterproof wires.
Deep Dimming	Excellent dimming performance to less than 1% with stable light output.
5 Year Warranty	Backed by the industry leading warranty of 5 years gives confidence in long term, maintenance free performance.

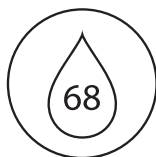

WATERPROOF

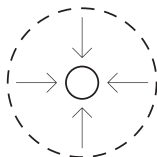

COMPACT SIZE



DEEP DIMMING



5 YEAR WARRANTY





Input Characteristics

Nominal Input Voltage Range AC	220-240 VAC
Absolute Input Voltage Range AC	198-264 VAC
Maximum Input Current @230 VAC / 50 Hz	51 mA
Input Frequency	50/60 Hz
Power Factor with Full Load	>0.9
Efficiency	83%
THD with Full Load	≤20%

Output Characteristics

Rated LED Output Power	15 W
Nominal LED Output Current	350 mA
LED Output Current Tolerance	±5%
LED Output Voltage Range DC	30-42 V
Startup Time	<0.5s

Dimming Characteristics

Dimming Type	Leading / Trailing Edge
Dimming Range	1% - 100%
Percent Flicker	<30%



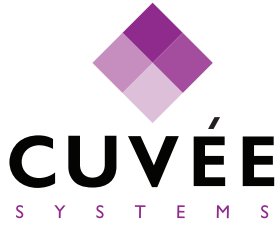

Environment Conditions

Operating Ambient Temperature (Ta) Range	-10 to 40 °C
Maximum Operating Ambient Temperature (Ta max)	40 °C
Maximum Operating Case Temperature (Tc max)	80 °C
Storage Temperature	-20 to 80 °C
Lifetime @ Tc max	50,000 hours

Mechanical Details

Length (L)	80 mm
Width (W)	33 mm
Height (H)	25 mm
Weight	90 g

Protection Features

Over Voltage Protection (OVP)	>43 V
Output Short-Circuit Protection	Yes
Surge Protection	1 kV





Outline Drawing

L x W x H
79.5 x 32.8 x 25.3 mm

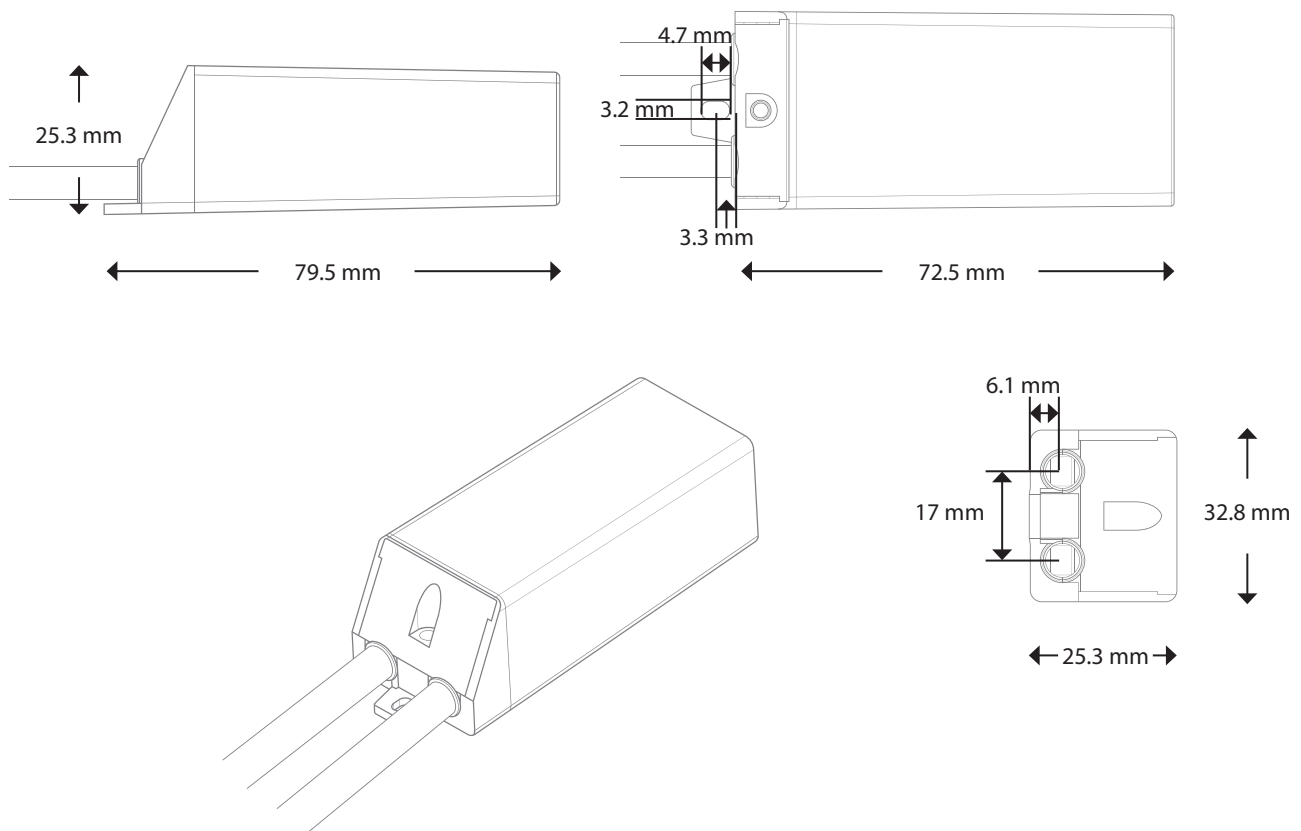



Wire Specifications

Input / Output Wire	H05RN-F
Input / Output Wire AWG	17 AWG
Input / Output Wire Diameter	8.0mm
Input / Output Wire Length	15 cm

Ordering Information

DR8-ELT015/1-CC350-42

Certifications and Testing

EN 55015:2013 + A1

EN 61000-3-2:2014

EN 61000-3-3:2013

EN 61347-1:2015

EN 61347-2-13:2014 + A1

EN 61547:2009



Warranty

Warranty Period 5 years

