



12W Compact LED Driver

The KAW/KCB series of compact LED drivers offers superior performance for small to medium size lighting fixtures, such as downlights, tracklights/spotlights and wall sconces where form factor, precise light control, quality of light and high reliability are critical factors.

Product Offering

Power: 12 W
 Input: 220-240 V (50/60 Hz)
 Output: 350 mA (30-38 V)
 Dimming: Leading and Trailing Edge
 IP rating: IP20



Features and Benefits

Compact Size	Specifically designed to fit in small lighting fixtures.
Flicker Free	World-class flicker free design ensures Percent Flicker less than 3% over the entire dimming range.
Deep Dimming	Excellent dimming performance to less than 1% with stable light output.
GloStart™	Turn light at low dimming level (i.e. <10%).
5 Year Warranty	Backed by the industry leading warranty of 5 years gives confidence in long term, maintenance free performance.

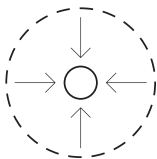

COMPACT SIZE

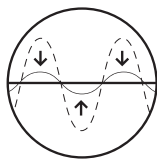

FLICKER FREE



DEEP DIMMING

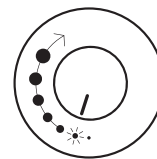

GloStart™



5 YEAR WARRANTY



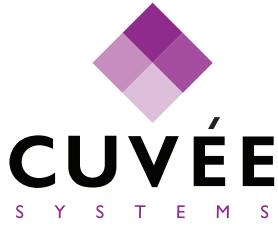

Input Characteristics

Nominal Input Voltage Range AC	220-240 VAC
Absolute Input Voltage Range AC	198-264 VAC
Maximum Input Current @230 VAC / 50 Hz	71 mA
Input Frequency	50/60 Hz
Power Factor with Full Load	>0.9
Efficiency	81%
THD with Full Load	≤20%
Maximum Inrush Current	<10 A

Output Characteristics

Rated LED Output Power	12 W
Nominal LED Output Current	350 mA
LED Output Current Tolerance	±3%
LED Output Voltage Range DC	30-38 V

Dimming Characteristics

Dimming Type	Leading / Trailing Edge
Dimming Range	1% - 100%
Percent Flicker	<3%



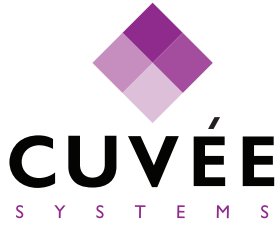

Environment Conditions

Operating Ambient Temperature (Ta) Range	-10 to 45 °C
Maximum Operating Ambient Temperature (Ta max)	45 °C
Maximum Operating Case Temperature (Tc max)	75 °C
Storage Temperature	-20 to 85 °C
Humidity	80%
Lifetime @ Tc max	50,000 hours

Mechanical Details

Length (L)	62.4 mm
Width (W)	56.5 mm
Height (H)	24 mm
Weight	95 g

Protection Features

Over Voltage Protection (OVP)	>43 V
Output Short-Circuit Protection	Yes
Surge Protection	1 kV





Outline Drawing

L x W x H
62.4 x 56.5 x 24 mm

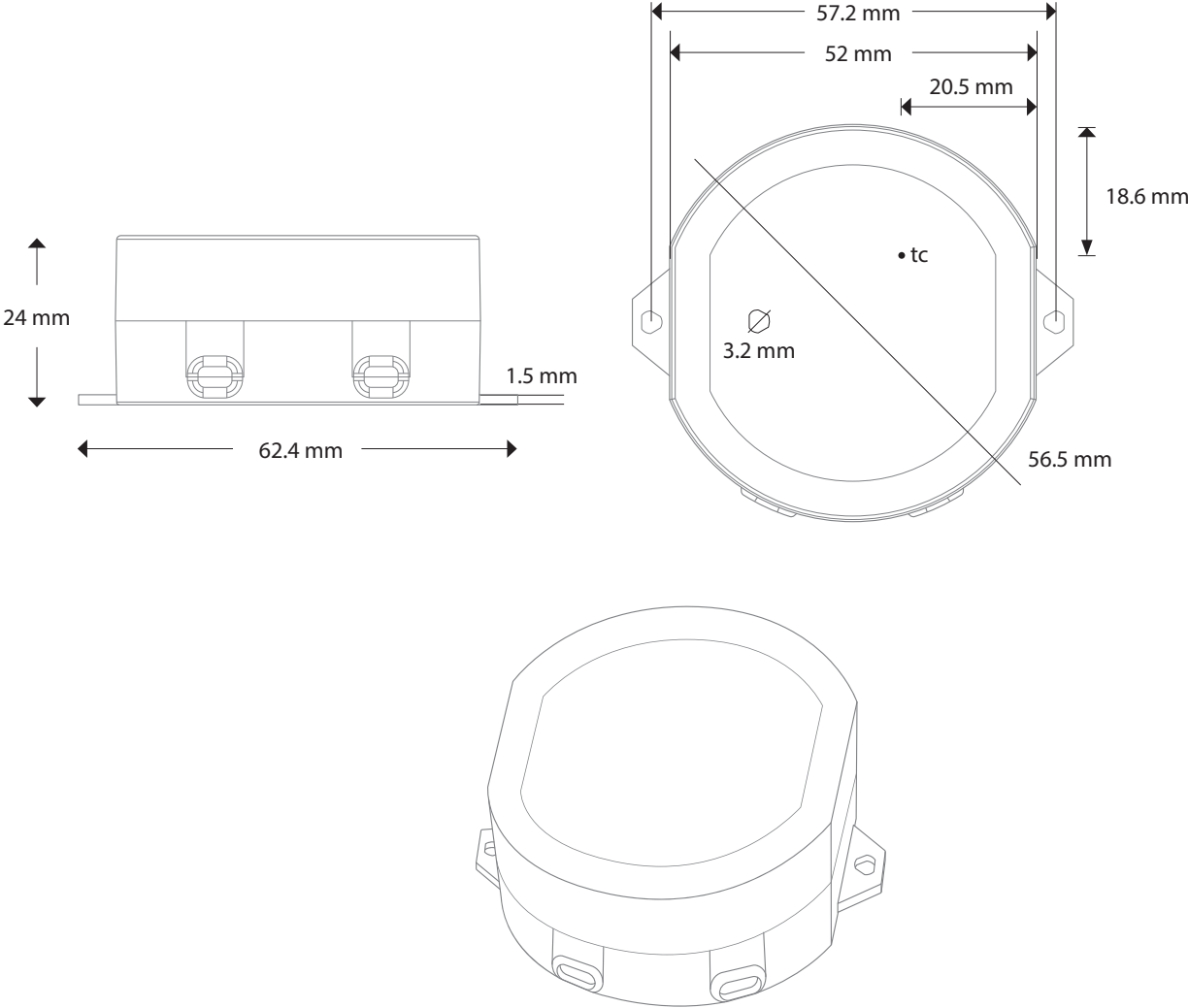

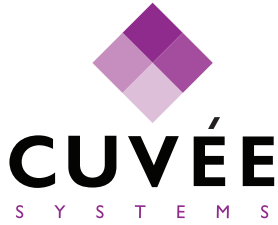

Wire Specifications

Input Wire	22 AWG
Output Wire	22 AWG
Wire Strip Length	10 cm

Ordering Information

KCB-12E35IAD/R

Certifications and Testing

EN 55015:2013 + A I

EN 61000-3-2:2014

EN 61000-3-3:2013

EN 61347-1:2015

EN 61347-2-13:2014 + A I

EN 61547:2009



Warranty

Warranty Period 5 years

